

# EBC10v2

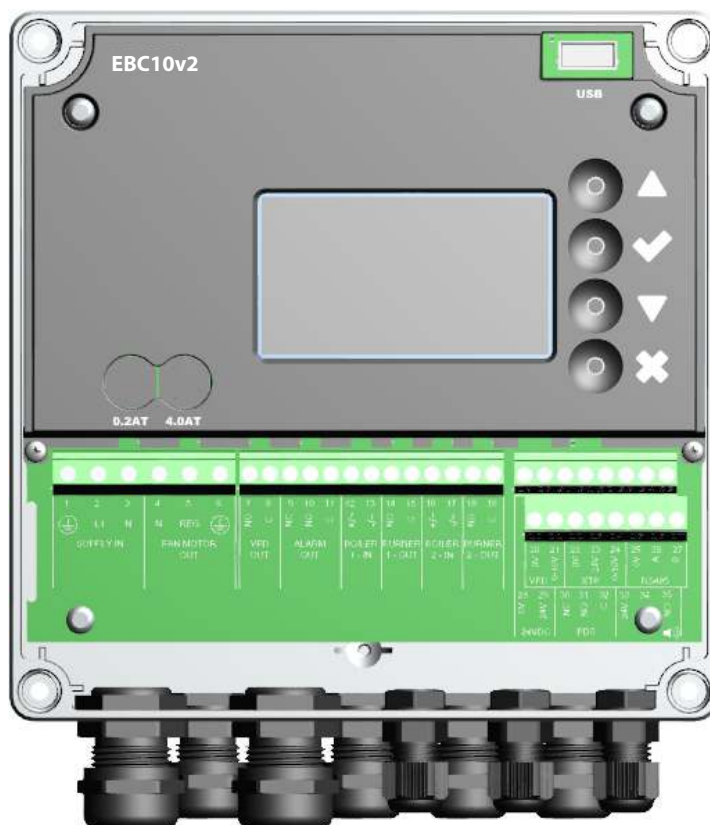

UK

## Fitting, installation and operating instructions

Read and save these instructions!

---

1.	Specifications .....	4
1.1	Dimensions and capacity .....	4
2.	Product information .....	5
2.1	Accessories .....	6
2.2	Fitting .....	6
2.2.1	Connection diagram .....	7
2.3	Layout of the user interface .....	8
2.3.1	Panel .....	8
2.3.2	Terminal board .....	9
2.4	Mechanical installation .....	10
2.5	Display .....	11
2.5.1	Using the interface .....	11
2.6	Introduction to the user interface .....	12
2.7	Setup .....	13
2.7.1	Chimney draft setting .....	13
2.8	Pre/post-purge .....	14
3.	Settings and troubleshooting .....	15
3.1	Error codes .....	15
3.2	Overview of the service menu .....	15
3.2.1	Light-emitting diodes and terminal board .....	17
3.2.2	Switch between the basic functions of pressure control and supply air .....	18
4.	Pressure regulation of exodraft chimney fans .....	19
4.1	Application .....	19
4.2	Functioning .....	19
4.3	Electrical connection .....	19
4.4	Wiring examples .....	19
4.4.1	One boiler .....	20
4.4.2	One boiler with potential free contact .....	21
4.4.3	One boiler and extra monitoring with PDS .....	22
5.	Pressure regulation of supply air fan .....	23
5.1	Application .....	23
5.2	Mode of operation .....	23
5.3	Electrical connection .....	23
5.4	Wiring examples .....	23
6.	EU Declaration of Conformity .....	24

---

**Symbols:**

The following symbols are used throughout this manual to bring attention to potential danger or to important information about the product.

**Prohibition symbol:**

Failure to observe instructions marked with a prohibition symbol is associated with serious injury or death.

**Danger symbol:**

Failure to observe instructions marked with a danger symbol is associated with personal injury or material damage.



TO REDUCE THE RISK OF FIRE, ELECTRICAL SHOCK, OR INJURY, OBSERVE THE FOLLOWING:

- Use this unit in the manner indicated by the manufacturer. If you have questions, contact the supplier.
- Before servicing the unit: Switch off the power and ensure that no one can turn it back on accidentally.
- Installation work should be done by qualified individuals according to applicable statutory regulations.
- Follow directions of the manufacturer along with general safety guidelines.
- This unit must be grounded during installation.

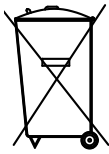
**Disposal:**

No special disposal requirements. Disposal of this product should be carried out in accordance with statutory regulations regarding electronic waste.

Installation: \_\_\_\_\_

Installer: \_\_\_\_\_

Installation Date: \_\_\_\_\_



# 1. Specifications

## 1.1 Dimensions and capacity

<b>exodraft EBC10v2 Styling</b>		
Power supply	V	1x 230 V / 50 Hz
Max. motor load	kW/hp	0.35/0.5
Operating temperature	°C	-20 to 50
Selection of operations	Pa	0-150
Tolerance	Pa	+/-5%
+24V supply	mA	100 Max.
Control signal VFD	VDC/mA	0-10 / Max. 10
Control and alarm relay	Max	230 VAC/4A AC1 - 24VDC/2A DC1
Boiler inputs		10-48 VDC / 10-230 VAC
VFD Relay	Max	230 VAC/2A AC1 - 24VDC/2A DC1
Output TRIAC	VAC	10-230
Dimensions	AxBxC	175 x 175 x 100 mm
Weight	kg	1.5
IP-rating		IP 54
Fuse	A	4.0T
<b>XTP-150 sensor</b>		
Power supply	VDC	24 VDC(+/- 15%)
IP-Rating		IP 54
Output	VDC	0-10 VDC, max 10 mA
Operating temperature	°C	-17 to 70
Tolerance	Pa	+/-5%
Dimensions	mm	80 x 82 x 55,5
<b>Chimney Probe</b>		
Dimensions	H mm	108
	I mm	89

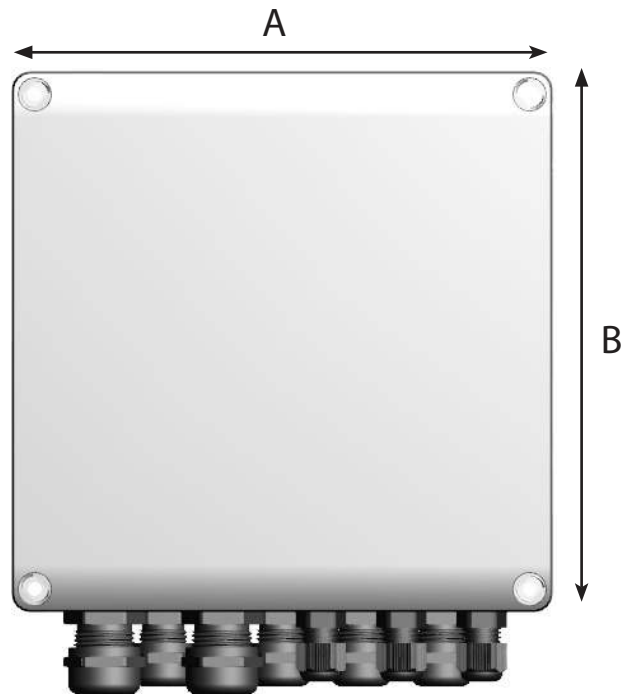

## 2. Product information

### Description

EBC10v2 (exodraft Boiler Control) is a specially developed control component for constant pressure regulation of chimney draft. Available in variant:

- EBC10v2EU01 is suitable for indoor installation

By changing the setup, EBC10v2 can also:

- Regulate the supply of fresh air to the boiler room (see section 4).

### Guide structure

EBC10v2 can be used either to control exodraft chimney fans or to control supply air fans.

The guide is divided into six sections::

- Section 1. Specifications
- Section 2. "Product Information".
- Section 3: Settings and Troubleshooting

Section 4: Pressure control of exodraft chimney fans (default setting).

- EBC10v2 ensures and monitors consistent pressure in the chimney.
- EBC10v2 can also be used for boiler systems with modulating burners.
- The automation monitors the draft in the chimney, disabling the burner in case of malfunction.
- The automation is designed for both solid fuel boilers, atmospheric gas boilers, and boilers with oil and gas blow torches.
- EBC10v2 can control a chimney fan directly or indirectly via a frequency converter.

Section 5: Pressure control of supply air fan.

- EBC10v2 is used for control of a supply air fan.
- EBC10v2 ensures and monitors consistent pressure in the boiler room.
- The automation monitors the pressure in the boiler room, disabling the burner in case of malfunction.
- EBC10v2 can control a supply air fan directly or indirectly via a frequency converter.

Section 6: EU Declaration of Conformity

EBC10v2 includes the following:

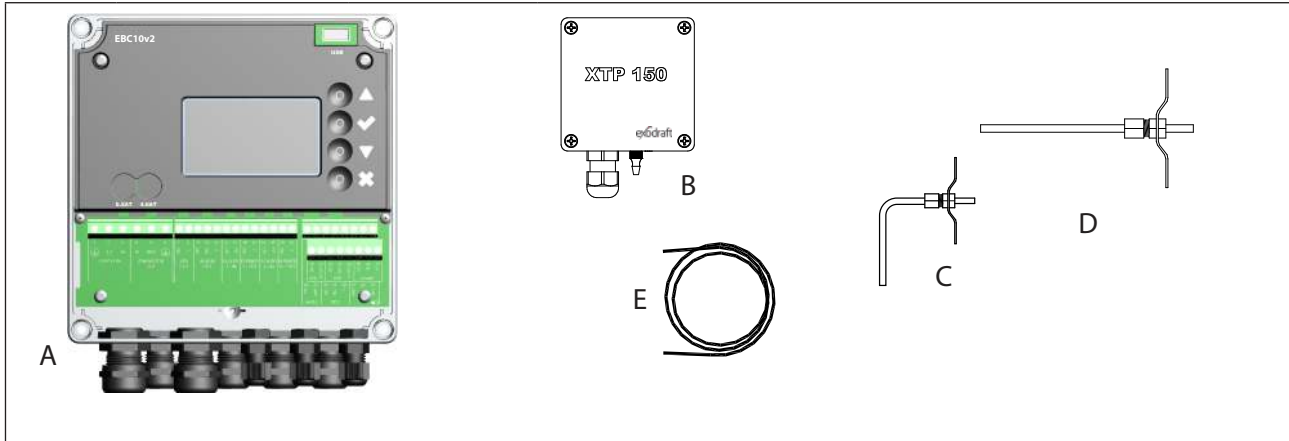

Pos.	Part	Item no.	Function
A	EBC10v2	EBC10v2EU01	Control of exodraft chimney fans and blow fans. For indoor installation.
B	Pressure transducer (XTP)	XTP150	Measures the air pressure in boiler room, chimney, or outdoor atmospheric pressure.
D	Measuring probe for EBC10v2EU01	3200813	Measures pressure in the chimney.
E	2 m. Silicone hose	2000335	Supplies the pressure transducer (XTP) with reference pressure from the measuring probe or from outdoors.
	Instructions	3120070	

## 2.1 Accessories

Part	Item no.	Function
Relay	ES12	For connection of more than two boilers
External PDS	PDSBOX	Measures pressure in the chimney
Rep. switch	REP-AFB	Isolation switch
Measuring probe 90°	3200814	Measures pressure in the chimney (Pos. C)

## 2.2 Fitting

### Cable length

Max. cable length between EBC10v2 and XTP: 100 m.

Max. cable length between EBC10v2 and chimney fan / fan: 100 m.

Max. cable length between XTP and measuring probe 2m.

## 2.2.1 Connection diagram

EBC10v2 is to be fitted and connected as shown in the diagram below.

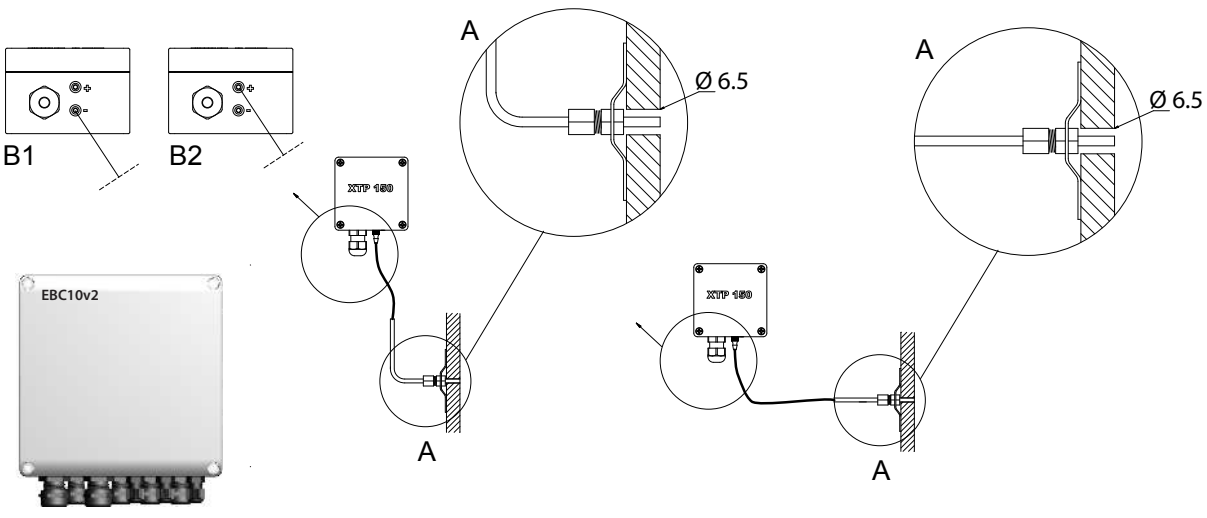
	
Control of.	Fitting procedure
Chimney fan	<ul style="list-style-type: none"> <li>• Install EBC10v2EU01 and the pressure transducer (XTP) in the boiler room.</li> <li>• Fit the measuring probe (A) in the boiler flue or in the manifold. However, for atmospheric boilers, the probe must always be positioned after the draft hood.</li> <li>• Connect the hose from the measuring probe to the negative terminal on the pressure transducer "B1".</li> </ul>
Note!	<ul style="list-style-type: none"> <li>• When the measuring probe is placed outside, it must be installed in a manner that prevents the formation of condensation or ice. EBC10v2EU01 comes with a straight measuring probe.</li> <li>• EBC10v2 must always be installed where it is protected from wind and weather (rain, snow, etc.)</li> </ul>
Supply air fan	<ul style="list-style-type: none"> <li>• Install the control and the pressure transducer (XTP) in the boiler room.</li> <li>• Connect the hose for measuring reference pressure (outdoor atmospheric pressure) to the negative terminal "B1" on the pressure transducer. Run the hose outside the building to a place not exposed to the weather. The open end of the hose may be installed inside a box as described at the top of the next page.</li> </ul>
Note!	<ul style="list-style-type: none"> <li>• Particularly when wanting positive pressure* in the chimney / boiler room:</li> <li>• Connect the hose to the positive terminal on the pressure transducer "B2".</li> <li>• EBC10v2 comes with only 2 m of hose.</li> </ul>

Note!



\*The default setting of the EBC10v2 is for negative pressure regulation, but local statutory regulations may require constant positive pressure.



\*\*Do not install the pressure transducer in an airtight enclosure, as it uses the atmospheric pressure for reference..

 Make sure to position the pressure transducer (XTP) correctly.

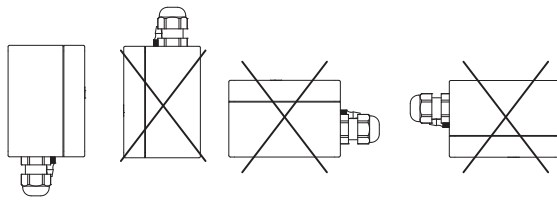

Note  
Do not blow into the valves of the XTP.





 For outdoor installation, place the pressure transducer where it is not exposed to the weather. For outdoor installation, the pressure transducer should be placed in a box fitted with a hole (Ø2mm) in the bottom. The hole serves to ensure correct reference pressure and prevent water entry

If the pressure transducer is positioned where insects have access to the free end, installing a sinter filter is recommended

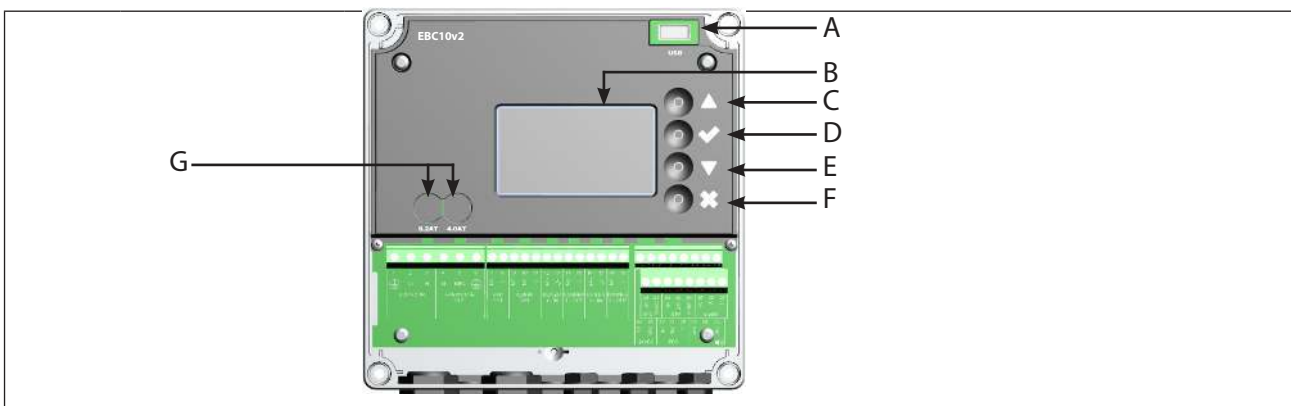
## 2.3 Layout of the user interface

### 2.3.1 Panel



Pos.	Del	Funktion
A	USB	<ul style="list-style-type: none"> <li>• USB Interface</li> </ul>
B	Display	<ul style="list-style-type: none"> <li>• Shows operation and changes in the user interface (menu system)</li> <li>• Indicates alarms</li> <li>• shows normal operation status</li> </ul>
C		<ul style="list-style-type: none"> <li>• Go forward/up in the menu system</li> </ul>
D		<ul style="list-style-type: none"> <li>• Approves your action</li> <li>• Forward</li> </ul>
E		<ul style="list-style-type: none"> <li>• Go down in the menu system</li> </ul>
F		<ul style="list-style-type: none"> <li>• Interrupt action</li> <li>• Back</li> </ul>
G	Fuse	<ul style="list-style-type: none"> <li>• Fuse type</li> </ul>



### 2.3.2 Terminal board

The following explains connection options for the terminal board

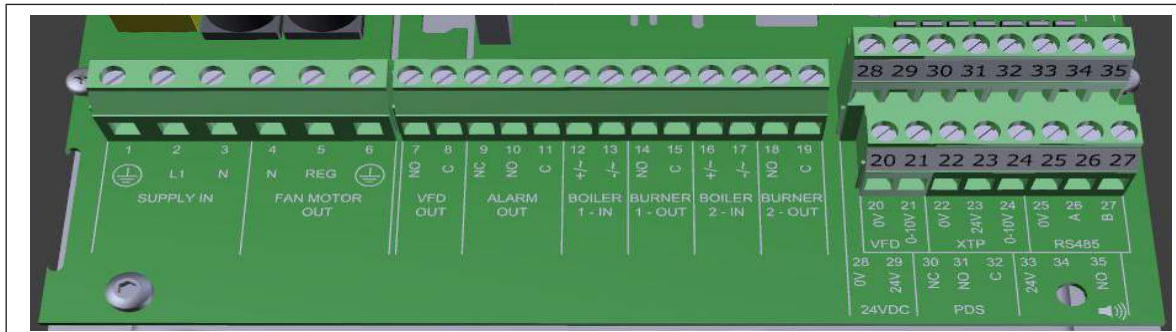

Terminal	Betegnelse	Terminal	Use
1	PE Ground	18	Inactiv
2	Supply - L1	19	Inactiv
3	Supply – N	20	Inactiv
4	Chimney fan – N	21	Inactiv
5	Chimney fan - L1 (Regulating)	22	XTP-0V DC power supply (transducer)
6	Chimney fan - PE Ground	23	XTP-24V DC power supply (transducer)
7	Frequency converter relay NO	24	Inactiv
8	Inactiv	25	Inactiv
9	Inactiv	26	Inactiv
10	Alarm Out - NO	27	0V DC Power supply
11	Alarm Out - C	28	24 VDC power supply (Max. 100 mA)
12	Voltage input from appliance / boiler 1 thermostat optocoupler (+) (10-230V AC/DC	29	24 VDC power supply (Max. 100 mA)
13	Voltage input from appliance / boiler 1 thermostat optocoupler (-) (10-230V AC/DC	30	PDS-NC (normally closed) Proven draft switch
14	Burner 1 relay switch-Normally open (max. 230 VAC, 2 amps.)	31	PDS-NO (normally open) Proven draft switch
15	Burner 1 relay switch-Common (max. 230 VAC, 2 amps.)	32	PDS-C (shared) Tested draft switch
16	Inactiv	33	Buzzer-24V DC supply
17	Inactiv	34	Not used
		35	Buzzer Signal

\* Cable length between 0-10V output (terminals 20 and 21) must not exceed 100 m of shielded cable 3 x 0,75 mm<sup>2</sup>.

\*\* However, terminals 30, 31, and 32 may be used for connecting other auxiliary monitoring equipment as well.

2.4 Mechanical installation

The control and the transducer must be installed inside, preferably in the boiler room. The control does not need to be installed in a cabinet.

EBC10v2 Control

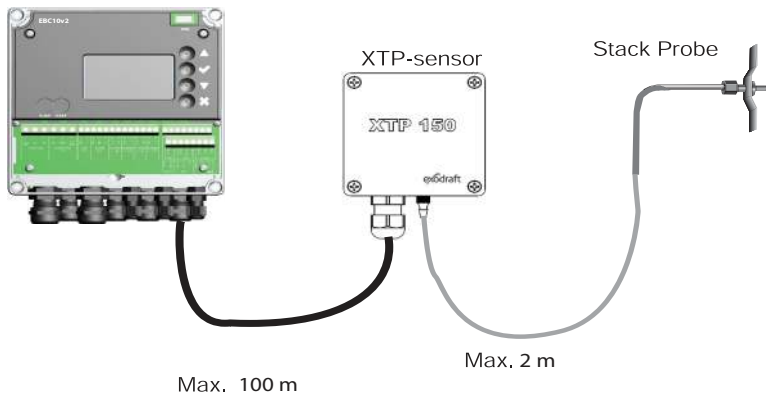

 Do not install the transducer in an airtight enclosure. It uses the boiler room pressure / atmospheric pressure as reference pressure.  
The control can be installed directly on the wall or somewhere similar.

Take off the lid.  
The installation holes are placed under the plastic screws keeping the cover in place.  
The distance between the control and the transducer should not exceed 100 m.

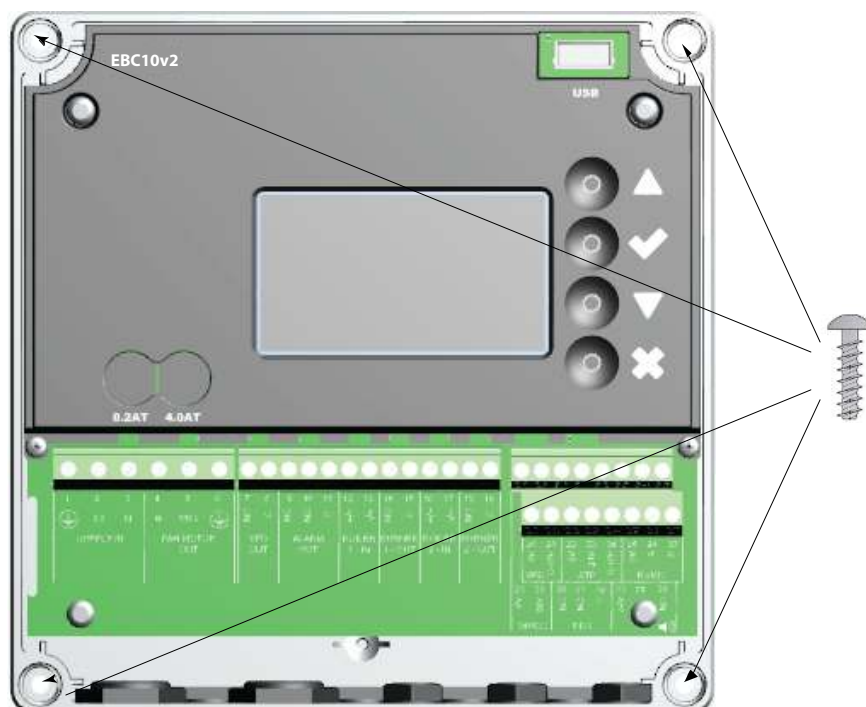

## 2.5 Display

The diagram below shows the layout of the display on the EBC10v2. All possible display values are indicated:





The purpose of the display is to indicate:

- Operating information (pressure, etc.)
- Alarms
- Parameters
- Set points
- USB

### 2.5.1 Using the interface

The user interface is operated via four buttons with the following functions:

Tast	Funktion
	<ul style="list-style-type: none"> <li>• Activate the service menu (press and hold for 5 seconds and enter code: 3142)</li> <li>• Edit and save settings</li> </ul>
	<ul style="list-style-type: none"> <li>• Go to menu item and adjust value</li> </ul>
	<ul style="list-style-type: none"> <li>• Return to operation screen from any point in the menu system</li> <li>• Reset alarm when "Manual Reset" is selected in menu 2.3.</li> </ul>

#### Access to the service menu

- Activate service menu (press and hold for 5 seconds)
- Enter code 3142
- Adjust value using the arrows.

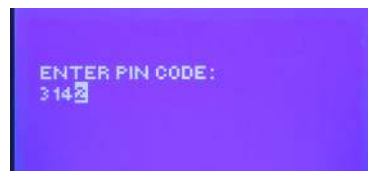

## 2.6 Introduction to the user interface

### Menu structure



Only qualified personnel should use the service menu

The service menu consists of four main menus, each divided into submenus.

- 1. Regulation
- 2. Alarms
- 3. Service
- 4. User interface







	Function description	Display indicates
Menu: 1	1.1 Pressure regulation: 0-95%: 0-150 Pa 1.2 Operating mode: Continuous or Intermittent 1.3 Pre-purge: Time and speed mode 1.4 Post-purge: Time and speed mode 1.5 Sensor: Range min. and max. 1.6 Properties: See page 15 (2.9 Service menu overview)	
Menu: 2	2.1 Error: Alarm type 2.2 Error log: Alarm log covering 19 readings 2.3 Reset: Automatic or manual	
Menu: 3	3.1. Version no. 3.2 I/O-view: Input/output monitor/activator 3.3 Option: Bearing cycle, prime, draft input delay. 3.4 Factory presets: Default settings 5 Manual mode: TRIAC/frequency converter output 0-100% 6 USB config: Updating of firmware, configuration files	
Menu: 4	4.1: Display: Language, units, and LCD settings	

See page 15 (2.9 Service menu overview) for detailed overview

## 2.7 Setup

### 2.7.1 Chimney draft setting

To set the pressure in the chimney, follow the procedure detailed below:







Trin	Handling	Display viser
1	<ul style="list-style-type: none"> <li>Start the system</li> <li>EBC10v2 displays the actual negative pressure (in this example, 55 Pa)</li> </ul>	
2	<ul style="list-style-type: none"> <li>Press and hold  for 5 seconds to get into the service menu</li> <li>Enter code: 3142</li> <li>Select menu 1</li> </ul>	
3	<ul style="list-style-type: none"> <li>Select menu 1.1</li> </ul>	
4	<ul style="list-style-type: none"> <li>Set required pressure</li> </ul>	

#### Note

This procedure only covers setting the pressure in the chimney.

## 2.8 Pre/post-purge

To set up pre-/post-purge period, follow procedure below:

Trin	Handling	Display viser
1	<ul style="list-style-type: none"> <li>Start the system</li> <li>EBC10v2 displays the actual negative pressure (in this example, 55 Pa)</li> </ul>	
2	<ul style="list-style-type: none"> <li>Press and hold  for 5 seconds to get into the service menu</li> <li>Enter code: 3142</li> <li>Select menu 1</li> <li>w</li> </ul>	
3	<ul style="list-style-type: none"> <li>Regulation 1</li> <li>Select menu 1.2 Pre-purge</li> <li>Select menu 1.3 Post-purge</li> </ul>	
4	<ul style="list-style-type: none"> <li>Select either 1.3.1 Time or 1.3.2 speed mode</li> </ul>	
5	<ul style="list-style-type: none"> <li>Set the desired time in seconds</li> <li>0-1800 seconds</li> </ul>	
6	<ul style="list-style-type: none"> <li>Fix 20-100</li> <li>or variable</li> <li>Finish and return to operation screen with</li> </ul>	

### 3. Settings and troubleshooting

#### 3.1 Error codes

Most terminal connections are monitored for correct operation. An LED light indicates operating status. If a light comes on, it is an indication that everything is functioning correctly, while a light going out indicates a problem in the circuit it monitors. In addition, error codes are shown on the display.

The error codes are:

Display	Explanation
A1 Draft Exhaust	Insufficient pressure may be due to: 1. Chimney fan has insufficient capacity 2. Mechanical or electrical fan failure 3. Blocked chimney 4. Introduction of excessive dilution air 5. XTP sensor not responding correctly
A2 Power Fault	Indicates that there has been a power fault
A3 XTP-Exhaust	Indicates a disconnected signal from the XTP sensor on the exhaust side to the control. May be caused by: 1. Loose connections 2. Faulty XTP-sensor 3. Defective controller
A4 Error Start	Indicates that the control has been unable to release the burner within 15 minutes.
A5 Alarm Override	Indicates alarm has been disregarded
A6 Draft Input	Missing signal from PDS function. Indicates a defective function.
A7 RS485 error	No communication between EBC10v2 and modbus network
A8 Priority	The draft has been insufficient and therefore the control has been in priority

#### 3.2 Overview of the service menu

The service menu is built in 4 levels and associated submenus.

Menu	Sub-menu	Function	Display	Description	Classification	Standard
<b>1</b>		<b>Exhaust</b>	<b>EXHAUST</b>			
	11	Draft set point	SET EXHAUST	Adjustment of exhaust setpoint.	2%-95% af sensor	17%
	12	Operation mode	EXHAUST MODE	Continuous or intermittent operation. In intermittent mode the exhaust fan runs only if one or more boiler inputs are active.	Continuous/ Intermittent	Intermittent
	<b>13</b>	<b>Pre-purge</b>	<b>PRE-PURGE</b>	<b>Pre-purge settings.</b>		
	131	Time	TIME	Pre-purge time in seconds	0-1800	0
	132	Operation mode	SPEED MODE	Select variable if the pre-purge should be controlled by the XTP-sensor or have a fixed speed.	Variable / FIX 20-100%	FIX 100%
	<b>14</b>	<b>Post-purge</b>	<b>POST-PURGE</b>			
	141	Time	TIME	Post-purge settings.	0-1800	0
	142	Operation mode	SPEED MODE	Select variable if the post-purge should be controlled by the XTP-sensor or have a fixed speed.	Variable / FIX 20-100%	Variable
	<b>15</b>	<b>Sensor</b>	<b>SENSOR</b>			
	151	Min. pressure	RANGE MIN	XTP minimum pressure in Pa.	-500 – 500 Pa	0
	152	Max. pressure	RANGE MAX	XTP Maximum pressure in Pa.	0 – 1000 Pa	150 Pa
	<b>16</b>	<b>Parameters</b>	<b>PROPERTIES</b>			
	161	Alarm limit draft	ALARM LIMIT	Select the alarm limit of the draft. The value is in % of the set point.	If 167 = "Negative" ->50 - 80 %. If 167 = "Positive" -> 150 - 300 %"	64 % (167 = "Negative") 144 % (167 = "Positive")
	162	Alarmdelay	ALARM DELAY	Select a alarm delay from 0-120 seconds.	0 – 120 s	15
	163	Min. voltage	SPEED MIN	Mimimum speed of the fan	0 – MENU 164	15 %
	164	Max. voltage	SPEED MAX	Maksimum speed of the fan.	MENU 163-100%	100
	165	Xp	EXHAUST Xp	Proportional gain.	0-30	15
	166	Ti	EXHAUST Ti	Integral gain.	0-30	8
	167	Sampling rate	SAMPLING RATE	Set the sampling rate for the PID Loop	1-10	10
	168	Pressure type	PRESSURE MODE	Positive or negative pressure in the stack.	Positive or Negative	Negative

Menu	Sub-menu	Function	Display	Description	Classification	Standard
	169	Application	APPLICATION	Sets if the control has to work as Exhaust or Intake	Exhaust / Intake	Exhaust
<b>2</b>		<b>ALARM</b>				
	21	Alarm Status	ERROR	The error is shown here		
	22	Alarm log	ERROR LOG	The last 10 alarms will be saved in the menu.		
	<b>23</b>	<b>Reset</b>	<b>RESET</b>	<b>Selecting "AUTO" will automatic reset the alarm after 15 seconds. If "MAN" is selected, the "X" has to be pressed.</b>	<b>MAN / AUTO</b>	<b>AUTO</b>
<b>3</b>		<b>Service</b>	<b>SERVICE</b>			
	31	Version no.	VERSION	Software version is showed.		
	32	I/O	I/O-VIEW			
	321	BURNER I/O	AUX OUT XXX AUX IN XX	In this menu the status of the boiler I/O is shown. By pressing ✓ the AUX OUT relays can be activated by pressing up and down. Multiple activations of the ✓ button will move from relay 1 to 6		
	322	EXHAUST I/O	EXH XTP x.xV OFF EXH VFD x.xV OFF	XTP, VFD and VFD relay status for Exhaust.		
	323	Draft input	DRAFT INPUT ON/ OFF	Draft Input I/O status.		
	324	Alarm relay	ALARM OUTPUT ON/OFF	Alarm relay output status.		
	<b>33</b>	<b>Options</b>	<b>OPTION</b>			
	331	Bearing cycle	BEARING CYCLE	Selecting "YES" will enable a bearing cycle on present fans, if the boilers has not been active for 24 hours.	ON/OFF	ON
	332	Allow prime		Selecting a number from 0-250 will enable the prime function. This allows the boilers to be activated even though no sufficient draft is present.	0-250 s / off	Off
	333	Draft Input Delay	DRAFT INPUT DELAY	The delay before the control goes into Fract Alarm	0-20 s	0 s
	<b>34</b>	<b>Factory reset</b>	<b>FACTORY</b>	<b>If "YES" is selected, a factory reset will be performed.</b>	<b>YES/NO</b>	<b>NO</b>

Menu	Sub-menu	Function	Display	Description	Classification	Standard
	36	USB configuration	USB CONFIG			
	361	format USB	FORMAT USB	Selecting "YES" will format the USB flash drive. Notice! All data will erased!	YES / NO	NO
	362	Data Log	DATA LOG USB / INTERNAL	Selecting "USB" will store the alarm log on the USB flash drive, "INT" will store the log in the internal memory.	USB / INT	INT
	363	Save config. file	SAVE CONFIG FILE	Selecting "YES" provides the possibility to select configurationfiles stored on the USB flash drive.	YES / NO	NO
	364	Load config. file	LOAD CONFIG FILE	Selecting "YES" will download the current configuration to the USB flash drive.	YES / NO	NO
	365	Upgrade firmware	UPGRADE FIRM- WARE	This function provides the possibility to upgrade the firmware by means of a USB Stick		
<b>4</b>		<b>User Interface</b>	<b>USER INTERFACE</b>			
	41	Display	DISPLAY			
	411	Language	LANGUAGE	Language.	ENG / FRA / ESP	ENG
	412	Pressure units	UNITS	Pa or inWC units.	Pa / inWC	inWC
	413	LCD backlight	LCD BACKLIGHT	LCD backlight turned on or not. The USE parameter will cause the backlight to be turned on if a button is pressed.	ON / OFF / USE	ON
	414	LCD contrast	LCD CONTRAST		10 – 100 %	50



### 3.2.1 Light-emitting diodes and terminal board

The chart below lists the terminal board connection options and light-emitting diode displays.

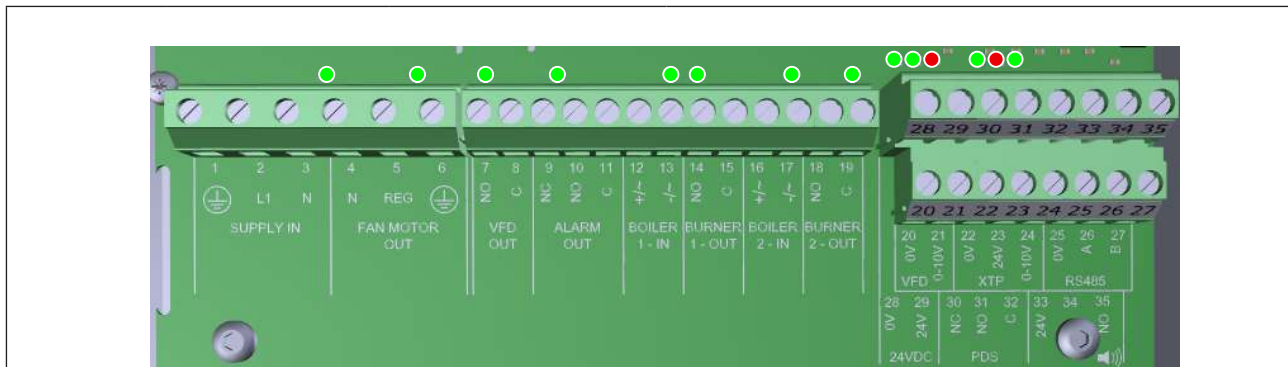

No.	Designation	Max. load	Meaning when the light-emitting diode is:
1, 2 og 3	SUPPLY IN	230-240 V AC +/- 10 %	green: EBC20 is connected to power supply
4, 5 og 6	FAN OUT	3A	green: the Triac output is active
7 og 8	VFD OUT	250 V AC, 8A, AC3	green: the relay is closed
9, 10 og 11	ALARM OUT	250 V AC, 8A, AC3	green: the relay is active
12 og 13	BOILER 1 IN	18 til 230 V DC/V AC	green: the input is active
14 og 15	BURNER 1 OUT	250 V AC, 4A, AC3	green: the relay is closed
16 og 17	Idle		
18 og 19	Idle		
28 og 29	24 V DC OUT	100 mA	green: voltage is OK red: overload
20 og 21	0 - 10 V OUT*	20 mA	green: output is active
22, 23 og 24	XTP IN		green: XTP connected red: return voltage > 12 V DC
30, 31 og 32	PDS IN **		green: C & NO are closed

\* Cable length between 0-10V output (terminals 20 and 21) must not exceed 100 m of shielded cable 3 x 0,75 mm<sup>2</sup>.





\*\* However, terminals 30, 31, and 32 may be used for connecting other auxiliary monitoring equipment as well.

### 3.2.2 Switch between the basic functions of pressure control and supply air

#### Default settings

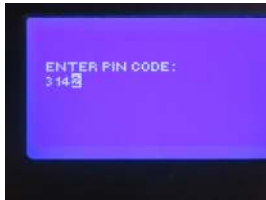
EBC10v2 defaults to constant pressure regulation of exodraft chimney fans (basic function 1 Exhaust/Intake)

#### Change of basic function

Step	Action	Display shows...				
1	<ul style="list-style-type: none"> <li>Press and hold ✓ for 5 seconds</li> </ul>					
2	<ul style="list-style-type: none"> <li>Enter code: 3142</li> <li>Use arrows to select followed by</li> </ul>					
3	<ul style="list-style-type: none"> <li>Select menu 1 Regulation</li> <li>Select menu 1.6 Properties</li> </ul>					
4	<ul style="list-style-type: none"> <li>Select menu 1.6.9 application</li> </ul>					
5	<table border="1" style="width: 100%;"> <tr> <td style="width: 50px; text-align: center;">1</td> <td>Pressure regulation of exodraft chimney fans (Exhaust)</td> </tr> <tr> <td style="text-align: center;">2</td> <td>Pressure control of Supply air fan (Intake)</td> </tr> </table>	1	Pressure regulation of exodraft chimney fans (Exhaust)	2	Pressure control of Supply air fan (Intake)	
1	Pressure regulation of exodraft chimney fans (Exhaust)					
2	Pressure control of Supply air fan (Intake)					
6	<ul style="list-style-type: none"> <li>Finish and return to operation screen</li> </ul>					

## 4. Pressure regulation of exodraft chimney fans

### 4.1 Application

#### Field of application

- EBC10v2 can also be used for boiler systems with modulating burners.
- The automation is designed for both solid fuel boilers, atmospheric gas boilers, and boilers with oil and gas blow torches.
- EBC10v2 can control a chimney fan directly or indirectly via a frequency converter.

### 4.2 Functioning

#### General function

- The automation monitors the draft in the chimney, disabling the burner in case of malfunction (the alarm diode on the EBC10v2 turns on).
- When the boiler thermostat demands heat, the chimney fan will start at max. voltage.
- When the EBC10v2 registers sufficient chimney draft, the burner is released.
- The EBC10v2 maintains the set pressure by regulating the voltage. The pressure is shown in the display.
- In the event of insufficient venting, the burner will initially be disconnected after 15 seconds. Insufficient venting is less than 64% of the set value, corresponding to less than 80% of flow.
- When the boiler turns off, the chimney fan stops as well. It is, however, possible to set a post-purge period for the chimney fan (see page 23). Alternatively, the control system can be connected in a way that keeps the chimney fan running continuously (see page 21).

#### Light-emitting diodes and output signals

All inputs and outputs are connected to a light-emitting diode for monitoring and servicing of the system (see section 2.9.1 Light-emitting diodes and terminal board, page 17)

EBC10v2 has 0-10V output signals for control of multiple chimney fans via frequency converters or motor power relays.

### 4.3 Electrical connection



This work must be performed by a qualified electrician in accordance with locally applicable rules and legislation.



Installation of the supply cable must comply with applicable legislation and regulations. The grounding terminal (  $\perp$  ) must always be connected.

**When connecting a pressure transducer (XTP) and frequency converter, shielded cable must be used.**

#### Isolation switch



**exodraft a/s stresses that according to EU's Machinery Directive, an isolation switch must be incorporated into the fixed installation. The isolation switch is not supplied by exodraft, but is available as an accessory.**

### 4.4 Wiring examples

As a constant pressure regulator for exodraft chimney fans, the EBC10v2 can be connected to a range of different signals. The following pages are wiring examples and illustrate the following:

- 4.4.1 One boiler, page 20
- 4.4.2 One boiler med potential free contact, page 21
- 4.4.3 One boiler and extra monitoring with PDS, page 21
- 4.4.4 One boiler connected to frequency converter, page 23
- 4.4.5 Two boilers with continuous operation of chimney fan, page 24



**exodraft recommends contacting the boiler manufacturer for correct connection to the boiler automation.**

4.4.1 One boiler

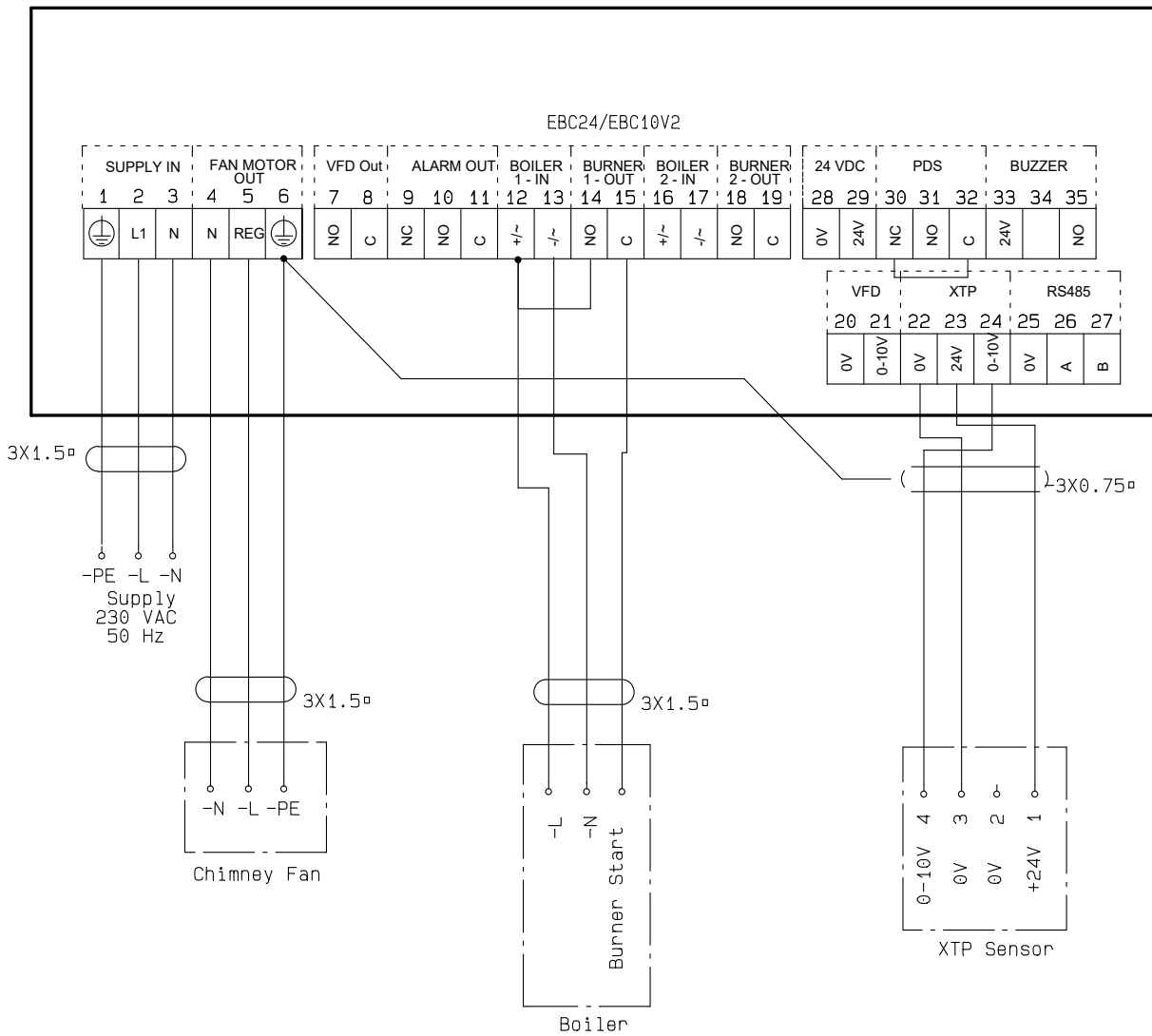

This example shows how to connect a voltage signal (18-230 V AC/DC) to EBC10v2 to start/stop the chimney fan.

- Connect the supply to terminals 1-3.
- Connecting the boiler:
- Connect the burner start signal (L) to terminal 12.
- Connect the neutral wire to terminal 13.
- The start signal for the burner is sent from terminal 15.
- Loop terminals 12 and 14.
- Connect the chimney fan to terminals 4-6.
- Connect the pressure transducer (XTP) to terminals 22-24 with a shielded cable, and connect the display to terminal 6

## 4.4.2 One boiler with potential free contact

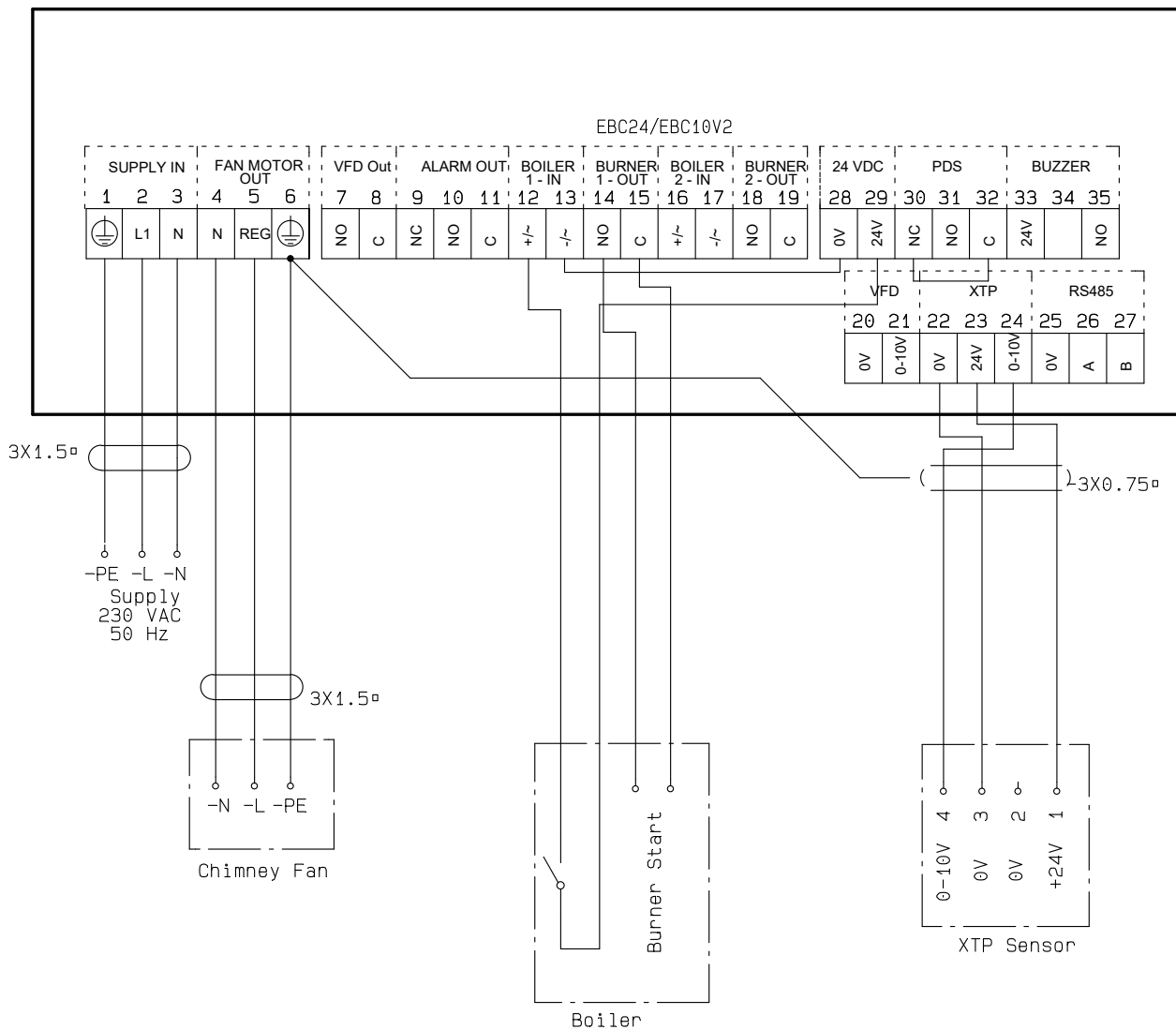

This example shows how to connect a potential free contact to the EBC10v2 to start/stop the fan:

- Connect the supply voltage to terminals 1-3.
- Connection to the boiler:
- Connect the potential free contact to terminals 12 & 29.
- Loop terminals 13 & 28.
- Connect the burner start signal to terminals 14 & 15.
- Connect the chimney fan to terminals 4-6.
- Connect the pressure transducer (XTP) to terminals 22-24 with a shielded cable, and connect the display to terminal 6.

4.4.3 One boiler and extra monitoring with PDS

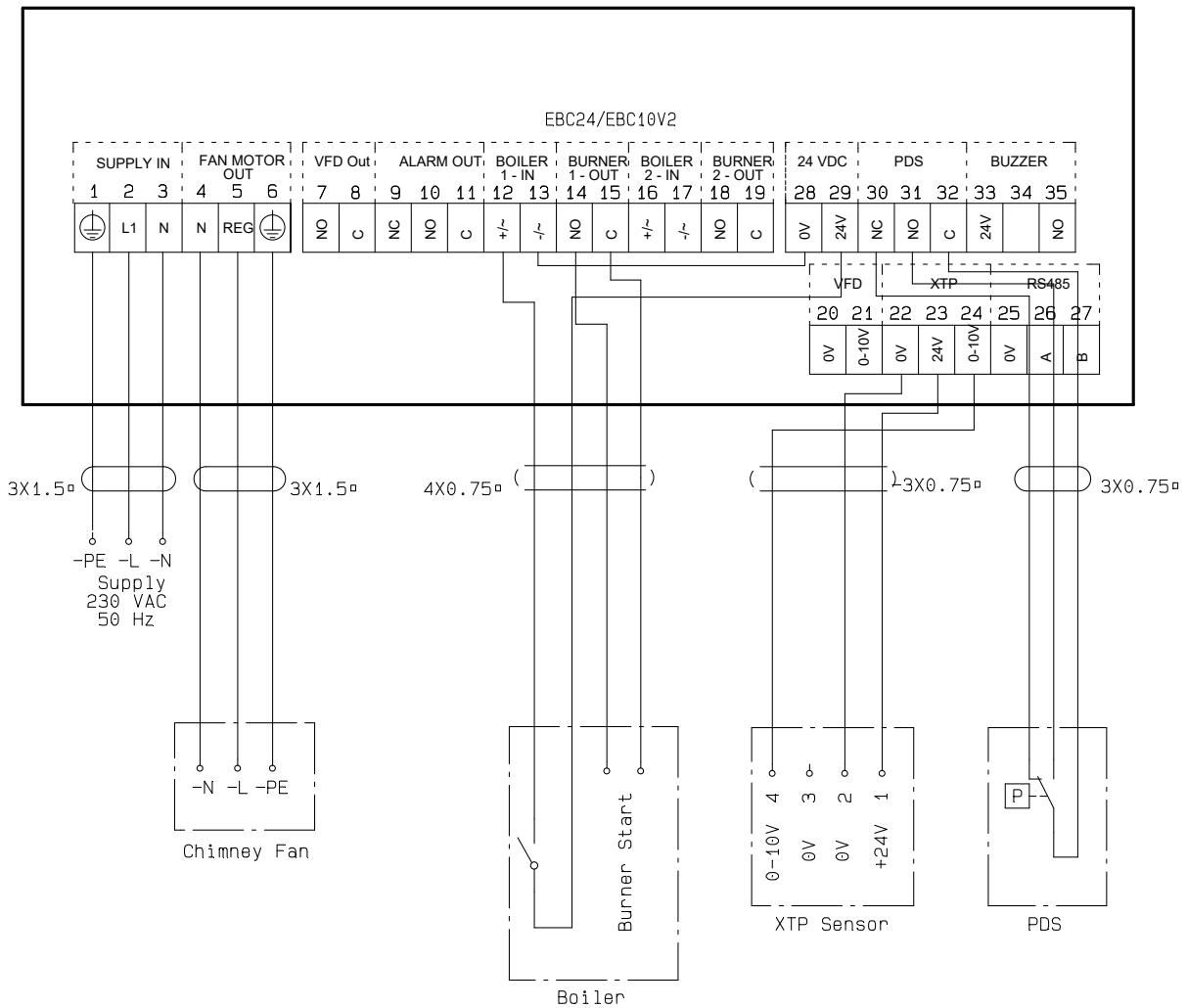

This example shows how to connect a PDS to EBC10v2. The PDS supplies extra monitoring

- Connecting PDS:
- Remove the factory installed wiring between terminals 30 and 32.
- Connect PDS to terminals 30, 31 and 32.
- Connect the supply to terminals 1-3.
- Connecting the boiler:
- Connect the potential free contact to terminals 12 & 29.
- Connect the burner start signal to terminals 14 & 15.
- Loop terminals 13 and 28.
- Connect the chimney fan to terminals 4-6.
- Connect the pressure transducer (XTP) to terminals 22-24 with a shielded cable, and connect the display to terminal 6.

## 5. Pressure regulation of supply air fan

### 5.1 Application

#### General

- The EBC10v2 is used to control a supply air fan.
- EBC can control a supply air fan directly or indirectly via a frequency converter.

#### Positioning

24 Install the EBC10v2 and the pressure transducer (XTP) in the boiler room as described in section 2.2 Fitting, pages 6+7

### 5.2 Mode of operation

#### General function

- The EBC10v2 monitors the pressure in the boiler room and disconnects the burner in the event of errors (the alarm diode on the EBC10v2 will turn on).
- When the pressure in the boiler room changes, the EBC10v2 will change the fan speed in order to meet the set point pressure for the boiler room.
- The EBC10v2 is connected to the boiler system in such a way that when a heating requirement arises, the EBC10v2 will start the fan, delaying the start of the boilers until the pressure in the boiler room is adequate.
- A safety function ensures that if the pressure in the boiler room is insufficient, the EBC22 will shut down the boilers the EBC10v2 will shut down the boilers, should the pressure in the boiler room become insufficient.

### 5.3 Electrical connection



This work must be performed by a qualified electrician in accordance with locally applicable rules and legislation.



Installation of the supply cable must comply with applicable legislation and regulations. The grounding terminal (  ) must always be connected.

When connecting a pressure transducer (XTP) and frequency converter, shielded cable must be used.

#### Isolation switch



**exodraft a/s stresses that according to EU's Machinery Directive, an isolation switch must be incorporated into the fixed installation.**

The isolation switch is not supplied by exodraft, but is available as an accessory.

### 5.4 Wiring examples

This example shows how to connect the EBC10v2 to a frequency converter/MPR-relay.



**exodraft recommends contacting the boiler manufacturer for correct connection to the boiler automation.**



## 6. EU Declaration of Conformity

### Declaration of Conformity



DK: EU-Overensstemmelseserklæring GB: Declaration of Conformity DE: EU-Konformitätserklärung FR: Déclaration de conformité de l'Union Européenne NO: EU-Samsvarserklæring	NL: EU-Conformiteits verklaring SE: EU-Överensstämmedeklaration FI: EU-Vaatimustenmukaisuusvakuutus IS: ESS-Samræmisstaðfesting IT: Dichiarazione di Conformità Unione Europea
<b>exodraft a/s</b> C.F. Tietgens Boulevard 41 DK-5220 Odense SØ	
-erklærer på eget ansvar, at følgende produkter: -hereby declares that the following products: -erklärt hierdurch auf eigene Verantwortung, daß folgende Produkte: -déclare, sous sa propre responsabilité, que les produits suivants: -erklærer på eget ansvar at følgende produkter:	-veklaart dat onderstaande producten: -deklarerar på eget ansvar, att följande produkter: -vastaa siltä, että seuraava tuote: -Staðfesti à eigin àbyrgð, að eftirfarandi vörur: -dichiara con la presente che i seguenti prodotti:
<b>EBC10v2</b>	
-som er omfattet af denne erklæring, er i overensstemmelse med følgende standarder: -were manufactured in conformity with the provisions of the following standards: -die von dieser Erklärung umfaßt sind, den folgenden Normen: -auxquels s'applique cette déclaration sont en conformité avec les normes ci-contre: -som er omfattet av denne erklæring, er i samsvar med følgende standarder:	-zijn vervaardigd in overeenstemming met de voorschriften uit de hieronder genoemde normen en standaards: -som omfattas av denna deklaration, överensstämmer med följande standarder: -jota tämä selvitys koskee, on seuraavien standardien mukainen: -sem eru meðtalin i staðfestingu Pessari, eru i fullu samræmi við eftirtalda staðla: -sono stati fabbricati in conformità con le norme degli standard seguenti:
<b>EN 60335-1, EN60335-2-102, EN 61000-6-1, EN 61000-6-2, EN 61000-6-3, EN 14459:2008</b>	
-i.h.t bestemmelser i direktiv: -in accordance with -entsprechen gemäß den Bestimmungen der folgenden Richtlinien: -suivant les dispositions prévues aux directives: -i.h.t bestemmelser i direktiv:	-en voldoen aan de volgende richtlijnen: -enligt bestämmelserna i följande direktiv: -seuraavien direktiivien määräysten mukaan: -med tilvisun til ákvarðana eftirlits: -in conformità con le direttive:
-Lavspændingsdirektiv: -the Low Voltage Directive: -Niederspannungsrichtlinie: -Directive Basse Tension: -Lavspenningsdirektivet:	-de laagspanningsrichtlijn: -Lågspänningsdirektivet: -Pienjännitedirektiivi: -Smáspennueftirlitið: -Direttiva Basso Voltaggio:
<b>2014/35/EC</b>	
-EMC-direktivet: -and the EMC Directive: -EMV-Richtlinie: -Directive Compatibilité Electromagnétique: -EMC-direktivet:	-en de EMC richtlijn: -EMC-direktivet: -EMC-direktiivi: -EMC-efirlitið: -Direttiva Compatibilità Elettromagnetica:
<b>2014/30/EC</b>	
Odense, 03.04.2017  -Adm. direktør -Managing Director  Jørgen Andersen  	-Algemeen directeur -Geschäftsführender Direktor -Président Directeur Général -Verkställande direktör -Toimitusjohtaja -Frankvemdastjóri -Direttore Generale











---

**DK: exodraft a/s**

C. F. Tietgens Boulevard 41  
DK-5220 Odense SØ  
Tel: +45 7010 2234  
Fax: +45 7010 2235  
info@exodraft.dk  
www.exodraft.dk

**SE: exodraft a/s**

Kasten Rönnowsgatan 3B 4tr  
SE-302 94 Halmstad  
Tlf: +46 (0)8-5000 1520  
info@exodraft.se  
www.exodraft.se

**NO: exodraft a/s**

Storgaten 88  
NO-3060 Svelvik  
Tel: +47 3329 7062  
info@exodraft.no  
www.exodraft.no

**UK: exodraft Ltd.**

10 Crestway, Tarleton  
GB-Preston PR4 6BE  
Tel: +44 (0)1494 465 166  
Fax: +44 (0)1494 465 163  
info@exodraft.co.uk  
www.exodraft.co.uk

**DE: exodraft GmbH**

Soonwaldstraße 6  
DE-55569 Monzingen  
Tel: +49 (0)6751 855 599-0  
Fax: +49 (0)6751 855 599-9  
info@exodraft.de  
www.exodraft.de